

# BE20 SERIES

Today's digital intelligence  
moves your gate.

Primo Florian: Founding partner - Engineering and design,  
Dino Florian: Founding President - Development and design,  
Renato Florian: Founding partner - Assembly and quality

## PEOPLE AND IDEAS

From the very beginning roger technology has evolved and grown because it's people believe that any bright idea can lead to great change in the future. Our people are passionate and innovative in our approach to every challenge, always pushing the boundaries to develop extraordinary products.

## PRODUCT EXPERIENCE

In our language we translate the word "experience" as passion. It is this passion that drives us in the development of revolutionary new products that serve the real needs of our customers. We understand that our customers want a product designed around the way that they work.



## Excellent raw materials

Steel, ductile cast iron, aluminium, bronze, copper and titanium have always been the main and exclusive raw materials used in the advanced engineering processes of our company.



## Production technology

At Roger Technology all internal manufacturing is carried out on optimised production lines making use of very advanced technology. We have invested heavily in robotics and automated all product manufacturing phases. This ensures that all components and semi-finished products are highly reliable, and are fully compliant with our exceptionally high quality standards.



## Internal assembly

Our highly qualified and dedicated staff oversee the fitting and assembly stages. Every piece of equipment is checked by our all Italian personnel to ensure that we deliver reliable products to our customers.

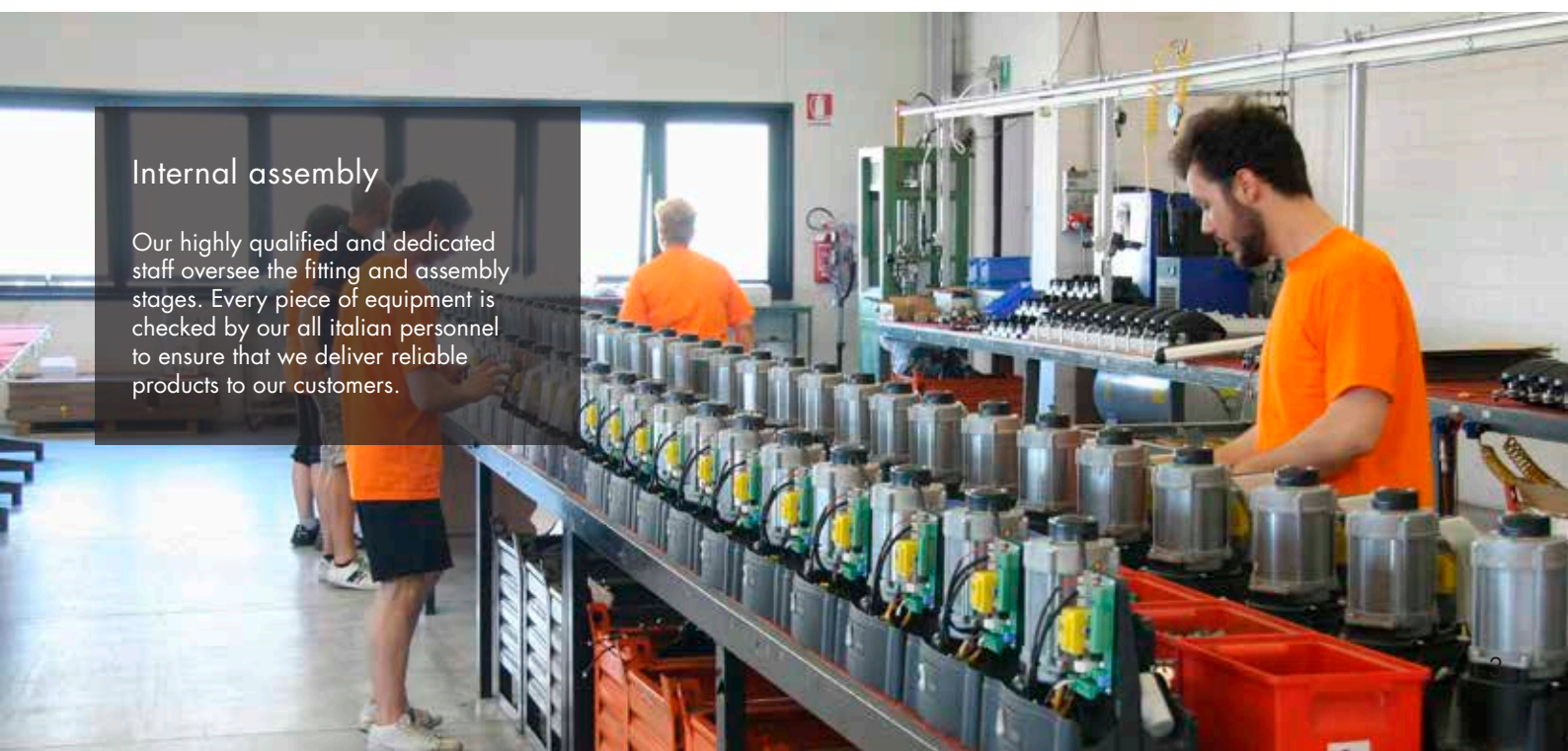

# Motor production

WE ARE THE CREATORS AT THE HEART  
OF THE PRODUCT!

All of our digital brushless motors are designed and  
manufactured in our own factories. Using dedicated  
automated machines the motors are wound with  
ultimate precision.



A digital brushless motor with permanent magnetic field, digital electronics for the complete management of the automation system control. Designed for super intensive use with the added benefit of a super low power consumption.

# THIS IS BRUSHLESS

## Digital Brushless Motor

Revolutionary and innovative digital Brushless motor with permanent magnetic field, 24V/36V three-phase sinusoidal power supply with native encoder that allows super-intensive use of the automation system with extremely low power consumption, not only providing 100% compliance with all control and safety requisites of the automation system.

## New Generation of Electronics

The new control unit with 24V/36V DC digital Brushless controller. Without traditional relays and due to the revolutionary MOSFET quadrant system and its control technology entirely based on a DSP (Digital Signal Processor) microcontroller, it represents a new generation of electronic cards created to safely handle all movement phases of the automation system.

## Engineering Passion

All the mechanical components and gears are manufactured in steel, cast iron and bronze; the automation system casings are made from titanium-reinforced die-cast aluminium. All the gears are inspected and assembled on high-quality bearings and inserted on precise seats machined to provide absolute precision between the axes.



### 3-PHASE DIGITAL BRUSHLESS MOTOR

A very powerful motor with substantial torque. The motor is compact and neat due to the special concentrated coil windings, it is powered by a three phase sinusoidal system.



### DIGITAL AND VECTORIAL AUTOMATION CONTROLLER

The BRUSHLESS digital controller, which operates at low voltage 24V/36V DC, allows 100% control of the automation system in digital mode. Due to its operation entirely based on a DSP microcontroller the travel and all the movements of your automation system can therefore be programmed and customised easily, precisely and elegantly.



### SPEED, ACCELERATION AND DECELERATION WITH EXTREME ELEGANCE

The automation system with brushless digital technology creates perfect and elegant movements. With a constant force and torque at every point and with the option of varying the speed on deceleration and acceleration the system can be managed with maximum safety.



### EXTREMELY LOW ENERGY CONSUMPTION

A motor that can operate at low voltage in super-intensive use and which can operate in environments with extremely demanding weather conditions while maintaining very low energy consumption and absorption levels. We can move a 600 kg sliding gate and use less than 30W of power.



### NO PROBLEM IN THE EVENT OF POWER FAILURE

With the help of internal or external batteries and the associated battery charging card, your automation system continues to operate for a considerable time even during prolonged power cuts, ensuring many more operations than traditional technologies.

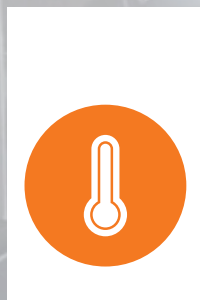

### MOTOR AT AMBIENT TEMPERATURE

The BRUSHLESS motor was brought into being with the main goal of being a motor for super-intensive use with an efficiency of 99%. Regardless of how many operations the engine performs in a day, it always remains cold or at most reaches the outside ambient temperature.

# COMPLETELY BRUSHLESS

The revolutionary digital motor which is 12 ways different



### THE DIGITAL SILENCE OF THE MOTOR

One great impact is the silence or the near absence of noise, generated by the BRUSHLESS motor during all its movements.



### MOTOR FOR SUPER-INTENSIVE USE

We wanted to surprise you with a fundamental fact: The super intensive use of the automation system with the motor which remains permanently cold even after many days of use.



### IMPACT, OBSTACLE DETECTION AND REVERSAL IN TOTAL SAFETY

Thanks to digital technology we are able to detect an obstacle and reverse the motor instantly, by simply specifying the torque of the motor, the sensitivity, the time and the travel of the reversal. And in complete compliance with all safety requisites.

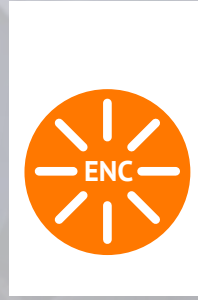

### ONBOARD NATIVE DIGITAL ENCODER

The BRUSHLESS motor has a highly advanced native digital encoder that controls management of automation systems in a safe, precise and extremely elegant manner.



### SIMPLE INSTALLATION WITH A SINGLE 3-WIRE CABLE

And the BRUSHLESS motor can be installed by simply connecting it using a single 3-wire cable! What could be easier? This will provide fully digital management of your automation system thanks to sensorless or sensed technology depending on the type of automation system.



### ADVANCED PRECISION ENGINEERING TO OBTAIN OPTIMAL MOTOR PERFORMANCE

We have created a mechanism that gives you the opportunity to get the maximum performance out of the motor. A product which combines the quality of the internal production processes, the mechanical processing and the use of high quality ferrous and non-ferrous materials.

# A technology that offers maximum performance but consumes less power than other motors

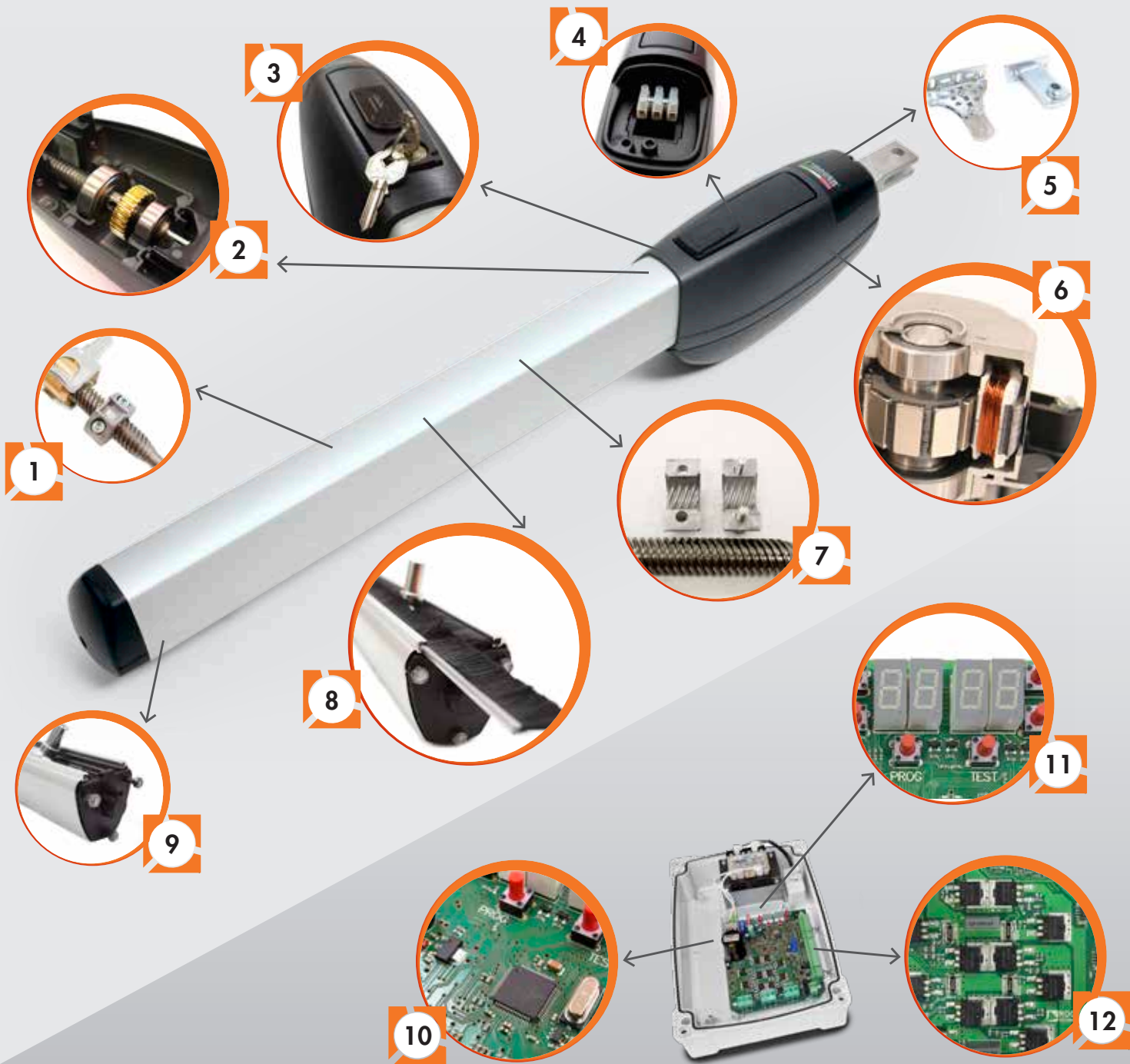

# WHY BRUSHLESS...?

Digital, smart, powerful,  
elegant, robust  
and all-Italian.





## 1 Sturdy, durable fork and nut screw

The fork and nut screw rotating in the worm gear are manufactured from superior quality materials. In particular, the bronze nut screw features a completely threaded inner surface and is press-fit onto the steel fork to ensure a precise mechanical connection.



## 7 Adjustable aluminium travel limits

The BE20 swing gate motor is factory-fitted with two aluminium travel limits reinforced with titanium in the gate open and gate closed positions. Both travel limits are adjustable and feature a completely threaded inner surface to form a solid mechanical connection with the worm gear during contact with the fork in both directions of movement of the motor. The travel limits are easily adjustable even with the motor already installed, by simply removing the aluminium cover.



## 2 High precision engineering

Reducer gears made with only with high quality materials such as aluminium, steel, cast iron and bronze; gears assembled with superior quality double shielded ball bearings to ensure absolute precision between axes.



## 8 Removable protection brushes

The extruded aluminium casing includes two specific guides for brushes preventing accidental contact and protecting and cleaning the worm gear and the relative fork. The brushes are removable and can even be replaced with the motor installed.



## 3 Eccentric release lever with barrel lock and key

The eccentric release lever is operated with a practical and durable barrel lock and key. The release system uses an extremely robust and resilient eccentric lever and a double lever lock mechanism, for manually releasing the automated system when needed simply and easily.



## 9 Elegant, reinforced aluminium casing

The casing covering the worm gear of the motor is manufactured from anodised aluminium, and features multiple reinforcement points along its entire length. The casing is fastened to the motor housing with through bolts crossing the full width of the casing.



## 4 Simple installation with a single 3-wire cable

The 3 input terminal board makes connection quick, simple and easy, with the motor connected to the digital controller with a single 3-wire cable.



## 10 Micro-controller with DSP SENSORLESS technology

Simply connecting the BRUSHLESS motor to the controller with a single 3-wire cable ensures completely digital control of your automated gate system with SENSORLESS motor power control technology.



## 5 Adjustable, screw-mounted fastener brackets

The BE20 brushless swing gate motor is equipped with screw-mounted adjustable fastener brackets, making the motor even quicker and easier to install on the gate. The brackets are oversized and manufactured from hot-galvanised carbon steel, for superior durability and to keep the motor fastened securely in place. The rear bracket offers a choice of 5 predetermined adjustment positions.



## 11 Multifunction digital display

4-quadrant digital display with 6 function keys that allow you to go through the various parameters, change their values, check error messages and input statuses and perform all the self-learning phases.



## 6 Brushless digital motor

Digital brushless motor based on a permanent magnetic field which uses neodymium iron-boron magnets inside the rotor. With innovative high density coil windings powered by a sinusoid three-phase power system, the motor of the BE20 is powered by low voltage (24V DC/36V DC). The motor is extremely compact and operates at normal ambient temperature, making it suitable for extremely intense use and extraordinarily energy efficient.



## 12 4 quadrant Mosfet digital inverter

The digital controller of the digital three-phase sinusoidal motor with field oriented control uses an extremely potent and revolutionary 12 Mosfet, 4 quadrant sinusoidal control digital inverter to control motor power with vector frequency modulation.

# Technical SPECIFICATIONS

|   | BE20/200   | BE20/200/HS  | BE20/400   |
|---|--|--|--|
| Maximum gate leaf length                                  | Up to 2.5 metres per single leaf                               | Up to 2.5 metres per single leaf   | Up to 4 metres per single leaf                                 |
| Line power supply   | 230V AC - 115V AC 50/60Hz +10%                                 | 230V AC - 115V AC 50/60Hz +10%   | 230V AC - 115V AC 50/60Hz +10%                                 |
| Brushless motor power supply                              | 24V  | 36V  | 36V  |
| Rated power   | 200W   | 200W   | 200W   |
| Frequency of use  | Super Intensive  | Super Intensive  | Super Intensive  |
| Operating temperature                                     | -20 +55°C  | -20 +55°C  | -20 +55°C  |
| Degree of protection                                      | IP43   | IP43   | IP43   |
| Maximum stroke  | 400 mm total   | 400 mm total   | 550 mm total   |
| Time to open to 90°                                       | 15 - 25 s  | 10 - 15 s  | 17 - 26 s  |
| Speed of operation  | 1,66 cm/s  | 3 cm/s  | 1,66 cm/s  |
| Thrust  | 100 - 2200 N   | 100 - 2200 N   | 100 - 2800 N   |
| Encoder   | Digital native encoder   | Digital native encoder   | Digital native encoder   |
| Limit switch type   | 2 adjustable open and closed position mechanical travel limits | 2 adjustable open and closed position mechanical travel limits                             | 2 adjustable open and closed position mechanical travel limits |
| Controller unit   | B70/2DC/BOX  | EDGE1/BOX (since version P3.05)  | EDGE1/BOX (since version P3.20)                                |
| Daily operation cycles (open / close - 24 hours Non-stop) | 800  | 800  | 1.000  |
| Packaged product weight                                   | 8,0 kg   | 8,0 kg   | 8,5 kg   |
| Release   | Eccentric lever with key cylinder                              | Eccentric lever with key cylinder  | Eccentric lever with key cylinder                              |
| Number of packages per pallet (single motor)              | 50   | 50   | 36   |
| Number of packages per pallet (motor in kit form)         | 21   | 21   | 18   |



# FUNCTIONS of automated swing gate motor

| DESCRIPTION  | BE20/200 - KIT BE20/210  | BE20/200/HS - KIT BE20/212/HS  | BE20/400 - KIT BE20/410  |
|--|--|--|--|
| Maximum length of single gate leaf                                       | up to 2.5 metres   | up to 2.5 metres   | up to 4 metres   |
| Digital controller   | B70/2DC/BOX (BE20/200)   | EDGE1/BOX (since version P3.05)  | EDGE1/BOX (since version P3.20)  |
| Radio receiver type  | H93/RX22A/1 with fixed code connection<br>H93/RX2RC/1 with rolling code connection   | H93/RX22A/1 with fixed code connection<br>H93/RX2RC/1 with rolling code connection   | H93/RX22A/1 with fixed code connection<br>H93/RX2RC/1 with rolling code connection   |
| Motor power supply   | 24V DC, with self-protected inverter   | 36V DC   | 36V DC   |
| Motor power control technology (ETPC)                                    | Field oriented control (FOC) with SENSORLESS technology  | Field oriented control (FOC) with SENSORLESS technology  | Field oriented control (FOC) with SENSORLESS technology  |
| Encoder type   | Digital SENSORLESS, 48 PPR   | Digital SENSORLESS, 48 PPR   | Digital SENSORLESS, 48 PPR   |
| Mains power supply   | 230V 50/60 Hz  | 230V 50/60 Hz  | 230V 50/60 Hz  |
| Battery operation  | (optional) 2 internal batteries (in digital controller box) 12V DC, 1.2 Amp/h<br>(optional) 2 external batteries 12V DC, 4.5 Amp/h | (optional) 2 internal batteries (in digital controller box) 12V DC, 1.2 Amp/h<br>(optional) 2 external batteries 12V DC, 4.5 Amp/h | (optional) 2 internal batteries (in digital controller box) 12V DC, 1.2 Amp/h<br>(optional) 2 external batteries 12V DC, 4.5 Amp/h |
| Energy consumption   | Very low consumption   | Very low consumption   | Very low consumption   |
| Number of motors   | 1 - 2 motors   | 1 - 2 motors   | 1 - 2 motors   |
| Power supply for accessories   | 24V DC   | 24V DC   | 24V DC   |
| Flashing light type  | 24V DC LED   | 24V DC LED   | 24V DC LED   |
| Output for gate opening indicator and automation System on warning light | √  | √  | √  |
| Output for courtesy light  | 40W  | 40W  | 40W  |
| Timed and guaranteed automatic closing                                   | √  | √  | √  |
| Gate edge safety management, 8.2KΩ or standard                           | √  | √  | √  |
| Limit switch type  | Adjustable open and closed position mechanical travel limits   | Adjustable open and closed position mechanical travel limits   | Adjustable open and closed position mechanical travel limits   |
| Separate management for motor 1 - 2                                      | √  | √  | √  |
| Force adjustment in nominal movement                                     | √  | √  | √  |
| Force adjustment in start-up and deceleration                            | √  | √  | √  |
| Obstacle detection - Motor reversal                                      | √  | √  | √  |
| Separate impact force setting for 2                                      | √  | √  | √  |
| Speed adjustment   | √  | √  | √  |
| Deceleration   | √  | √  | √  |
| Starting acceleration (soft-start)                                       | √  | √  | √  |
| Guaranteed closing   | √  | √  | √  |
| Wind protection function with gate closed                                | √  | √  | √  |
| Motor stopping distance and braking distance                             | √  | √  | √  |
| Partial opening control  | Pedestrian entry   | Pedestrian entry   | Pedestrian entry   |
| Human presence control   | √  | √  | √  |
| Lock management  | √  | √  | √  |
| Condominium function   | √  | √  | √  |
| Safety device configuration  | √  | √  | √  |
| Installation test function   | (prog button)  | (prog button)  | (prog button)  |
| Operating temperature  | -20°C/+55°C  | -20°C/+55°C  | -20°C/+55°C  |
| Inverter thermal protection  | √  | √  | √  |
| Current absorption mapping system  | (MCA)  | (MCA)  | (MCA)  |
| Restore factory default values   | √  | √  | √  |
| Information on use of motor  | √  | √  | √  |
| Security password management   | √  | √  | √  |

# Dimensions

BE20/200 - BE20/200/HS  
BE20/400

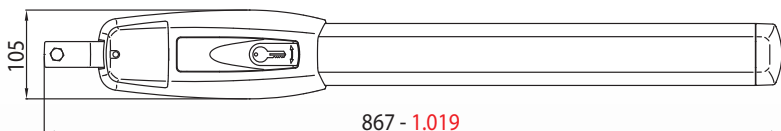
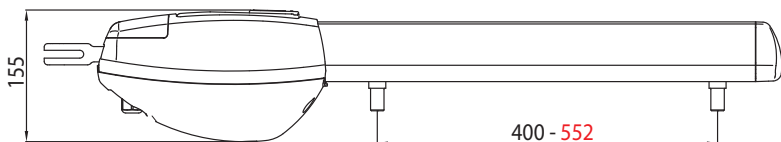

# Operating limits

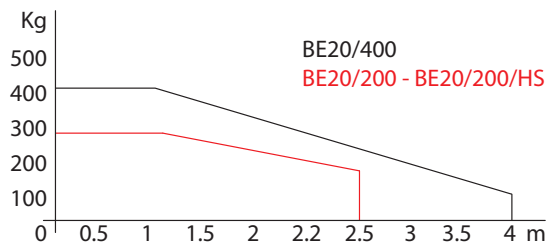

| BE20/200 - BE20/200/HS (MAX RUN = 400 MM) |     |         |         |    |                |
|---|-----|---------|---------|----|----------------|
| A   | B   | C (max) | D (max) | E  | $\alpha^\circ$ |
| 110                                       | 180 | 100     | 770     | 92 | 100°           |
| 110                                       | 210 | 100     | 770     | 92 | 95°            |
| 120                                       | 150 | 100     | 770     | 92 | 105°           |
| 120                                       | 200 | 100     | 770     | 92 | 100°           |
| 130                                       | 130 | 100     | 770     | 92 | 105°           |
| 150                                       | 130 | 100     | 770     | 92 | 120°           |
| 150                                       | 150 | 100     | 770     | 92 | 110°           |
| 150                                       | 200 | 100     | 770     | 92 | 100°           |
| 160                                       | 150 | 100     | 770     | 92 | 105°           |
| 160                                       | 160 | 100     | 770     | 92 | 100°           |

| BE20/400 (MAX RUN = 550 MM) |     |         |         |     |                |
|-----------------------------|-----|---------|---------|-----|----------------|
| A                           | B   | C (max) | D (max) | E   | $\alpha^\circ$ |
| 120                         | 180 | 150     | 922     | 125 | 100°           |
| 120                         | 200 | 150     | 922     | 125 | 95°            |
| 150                         | 180 | 150     | 922     | 125 | 105°           |
| 150                         | 220 | 150     | 922     | 125 | 100°           |
| 170                         | 200 | 150     | 922     | 125 | 105°           |
| 170                         | 270 | 150     | 922     | 125 | 120°           |
| 200                         | 200 | 150     | 922     | 125 | 110°           |
| 200                         | 240 | 150     | 922     | 125 | 100°           |
| 220                         | 180 | 150     | 922     | 125 | 110°           |
| 220                         | 200 | 150     | 922     | 125 | 100°           |

# Preparations for standard installation

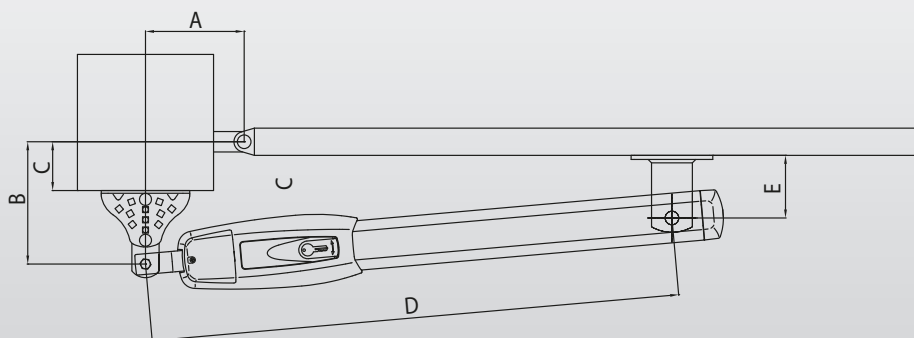

kits

In **KIT BE20/210**,  
**KIT BE20/212/HS**  
for swing gates up to 2.5 m  
and **KIT BE20/410** for  
swing gates up to 4 m

# Contents of standard BE20 swing gate motor kit

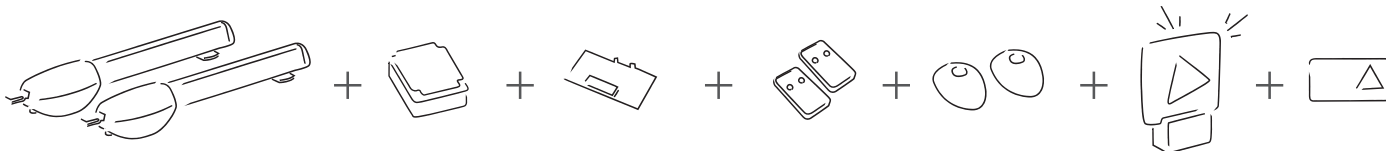

2 swing gate motors

1 controller unit

1 radio receiver with 2 fixed code channels, H93 series

2 fixed code remote control units with copying function, E80 series

1 pair of photocells, R90 series

24V DC LED flashing lamp unit with integrated antenna

1 "Automatic Opening" warning notice

The composition of the kit is subject to change in the nature or quantity of the items. For the correct content of the kits always refer to the catalogue, the current sales price lists or the online product catalogue at [WWW.ROGERTECHNOLOGY.COM](http://WWW.ROGERTECHNOLOGY.COM)

# ACCESSORIES

BE20, everything you need for a complete, professional installation.

## OPTIONAL ACCESSORIES



KT201

Long front bracket, to weld,  
BE20/400 series



KT205

Kit with three long brackets  
to weld, BE20/400 series



KT202

Short front bracket, to weld,  
BE20/200 - BE20/200HS  
series



KT206

Kit with three short brackets  
to weld, BE20/200 -  
BE20/200HS series



KT203

Short rear bracket, to weld,  
BE20/400 series



R99/C/001

"Automatic Opening"  
warning notice



KT204

Short rear bracket, to weld,  
BE20/200 - BE20/200HS  
series

## STANDARD ACCESSORIES (Always included in the individual product package or kit)



KT205/R  
Kit long brackets  
BE20/400 series



KT206/R  
Kit short brackets  
- BE20/200  
- BE20/200HS



MC781  
Two mechanical  
stop kits  
- BE20/400  
- BE20/200  
- BE20/200HS

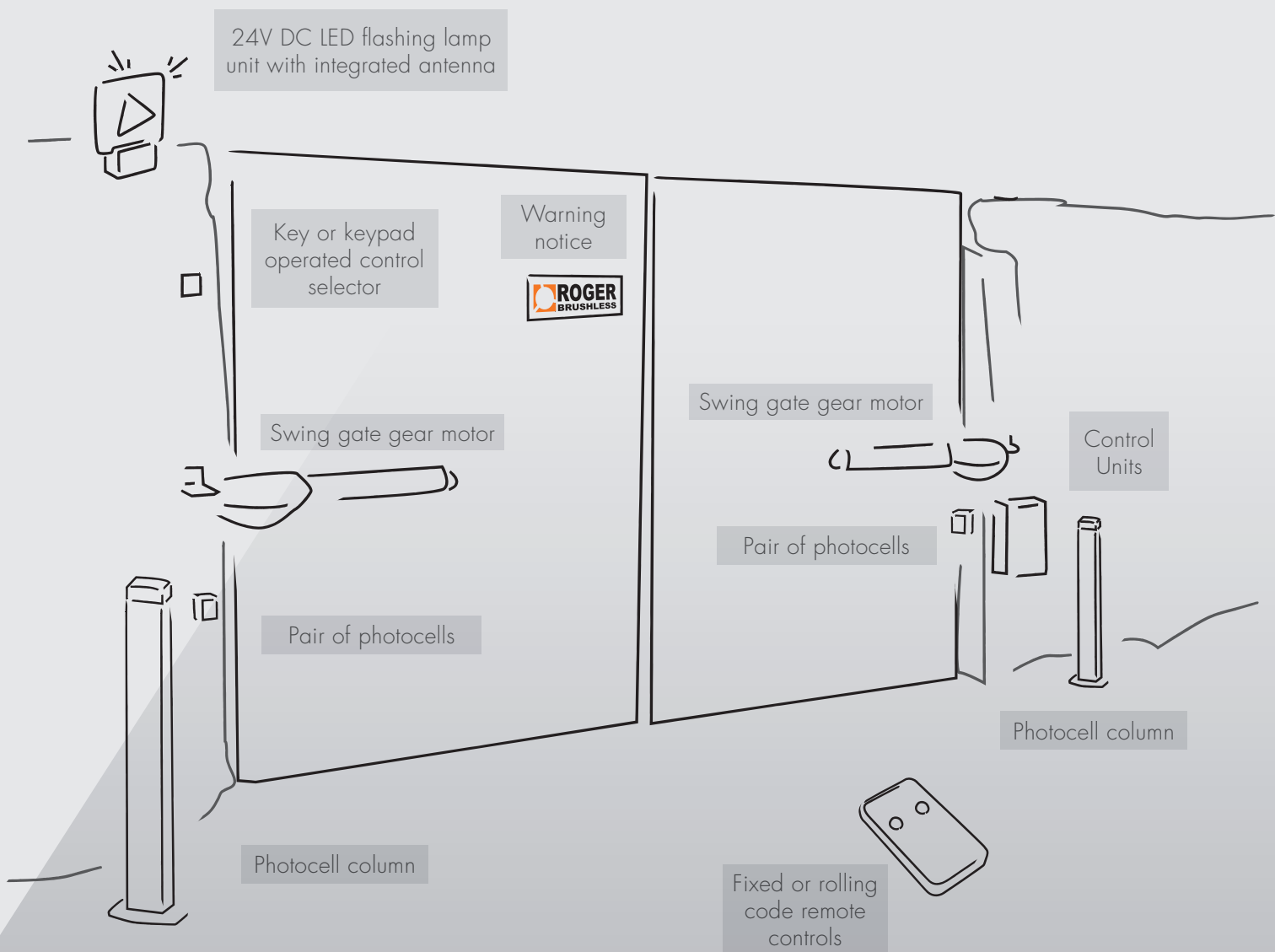

# STANDARD INSTALLATION

a practical example  
for your successful  
installation



# BE20 *HIGHSPEED*

the digital speed  
takes off!

**100%**  
FASTER

**MANAGE**  
SEPARATE SPEED IN  
OPENING AND CLOSING

**MANAGE**  
SEPARATE SLOW DOWNS  
AND ACCELERATIONS IN OPENING  
AND CLOSING

**100%**  
SAFETY THANKS TO ITS STARTING  
POINT OF SLOW DOWNS WITH  
ITS RELATED SPEED



WWW.WEAREBRUSHLESS.COM



PREMIUM DEALER / AUTHORISED DEALER



# ROGER TECHNOLOGY

Via S. Botticelli, 8 - 31021, Bonisiolo di Mogliano Veneto (TV) - ITALY  
T. +39 041 5937023 - F. +39 041 5937024

WWW.ROGERTECHNOLOGY.COM

