

TMT AUTOMATION AUSTRALIA PTY LTD
ABN_57631683835 ACN_631683835
Unit 5/364 Woodpark Rd,
Smithfield, Sydney, NSW 2164
Tel: +61 (0) 423225069
Email: sales@tmt-automation.com
Website: www.tmt-automation.com



TMT Chow! APP



TMT Website

TMT CHOW!



IDEAS FOR A SIMPLER, SMARTER LIFE

Integrated automation for garage doors, gates with
security doorbells, security cameras, and more



www.tmt-automation.com

Chow! In Hand

Manage Your Home Door Anytime,
Anywhere.

Download Chow! For Free

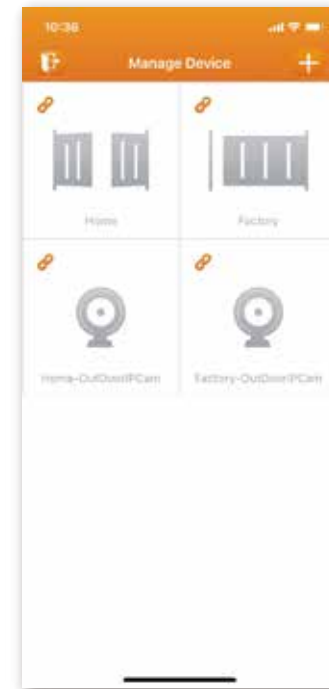
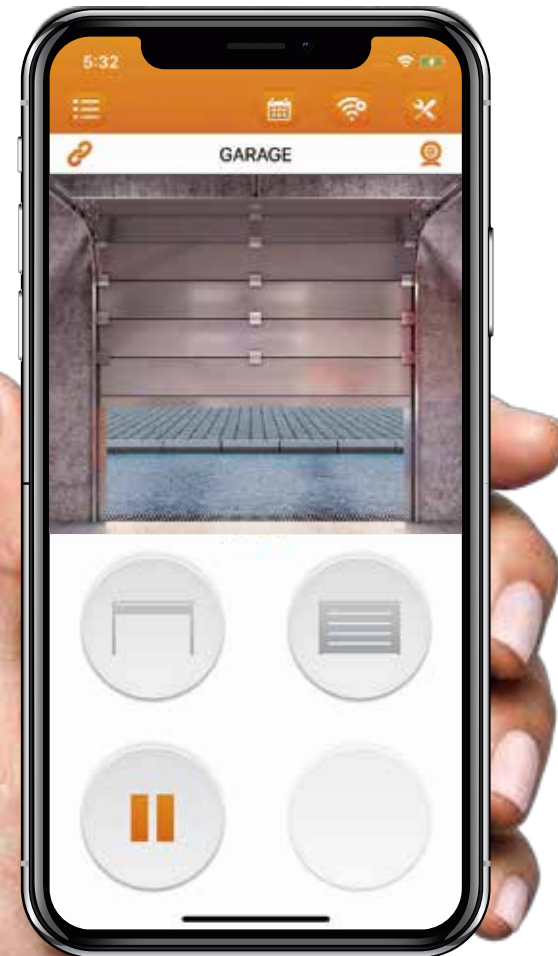

Convenient

- All your devices on one app
- Check and monitor from anywhere

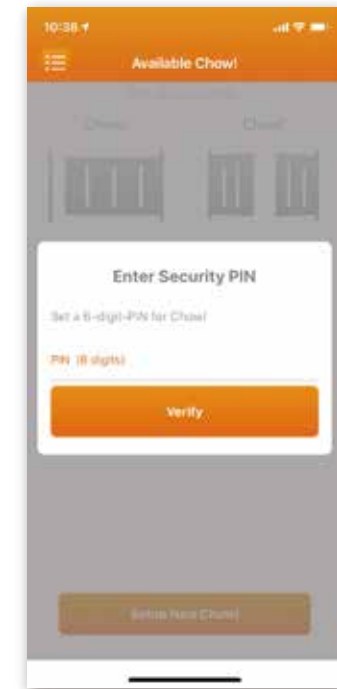

Secure

- PIN code protection for your devices
- Check your door through Chow Cam

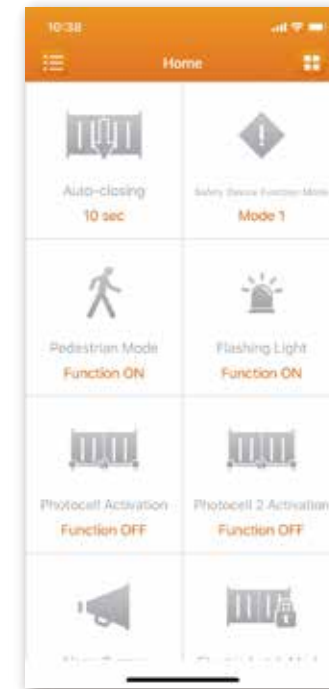

Easy

- Program the motor with the Chow! app with ease
- Includes simple setup guide

Make Your Home Security System Complete

Chow Bell

When Chow Bell rings will automatically send an instant alert to let you know a visitor is here. It allows you to be aware right away instead of running to the front door to check



Receiver At Home

You can set up multiple receivers and Chow Bells for any type of house

Phone Notification

Chow Bell notifies you when someone is visiting when you are not home.

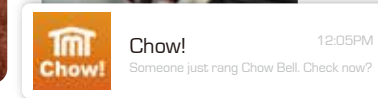

Chow Cam

Securer Solution For Home

Set up Chow Cams at your front entrance and in the indoor space to make sure every corner of your house is safe.

Control With Smartphone

Check who is visiting through the Chow app. Unlock your door remotely with your smartphone.





Automation for Garage doors

COBBLE 80/100/120



Auto Detection

Allows users to check the current status of the motor while in operation

Extra Safety

Smooth operation with soft start/stop
Obstruction detection sensor
Lighten up every corner of your garage.

Smartphone Control

Remotely open and close doors with the Chow! app
Programming the motor through Chow! app
Extra home security and convenience with the Chow! Cam from anywhere and on any device.



Application Diagram

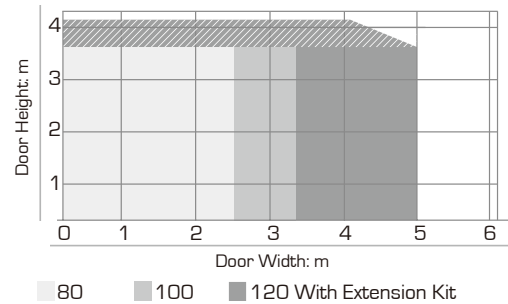

Dimensions

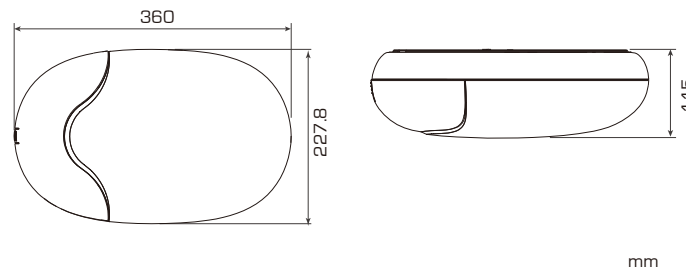

Basic Installation

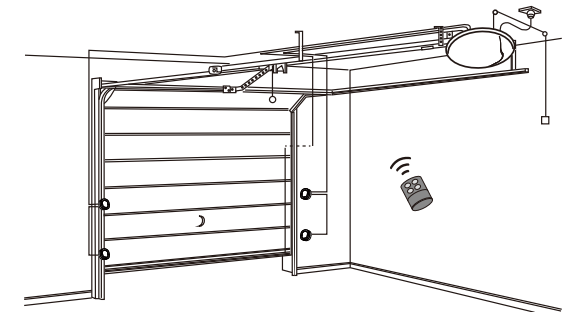

Model Name	COBBLE 80	COBBLE 100	COBBLE 120
Peak Pulling Force	800N	1000N	1200N
Motor Volt	DC24V	DC24V	DC24V
Power	80W	100W	144W
Rated Door Area	16m ²	18m ²	24m ²
Rail	Steel	Steel	Steel
Rail Length	3.3m/3.6m/3.9m	3.3m/3.6m/3.9m	3.3m/3.6m/3.9m
Drive	Chain/Belt	Chain/Belt	Chain/Belt
Speed (mm/sec)	140	140	140
Soft Start / Soft Stop	V	V	V
Lighting System	LED	LED	LED
Self Learn Force System	V	V	V

Accessories

Smart Phone Control	V (Standard)	V (Standard)	V (Standard)
4 Button Transmitters	X2	X2	X2
Wall Transmitters (Optional)	●	●	●
Safety Beams (Optional)	●	●	●
Wireless Keypad (Optional)	●	●	●
Wireless Doorbell (Optional)	●	●	●
IP Camera (Optional)	●	●	●
Built-in IP Cam			

Security System

Basic Access Kit



Gate Opener,
2x Transmitters, Chow! app

Smart Starter Kit

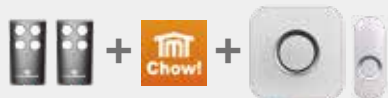

Gate Opener, 2x Transmitters, Chow! app, Chow Bell

Secure Pro Kit

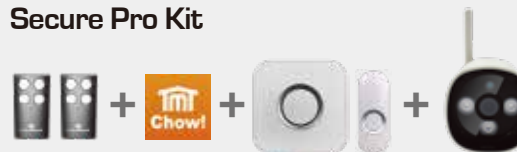

Gate Opener, 2x Transmitters, Chow! app, Chow Bell, Chow Cam

Basic Access Kit (gate opener, transmitters 2 pcs, Chow App). Smart Starter Kit (gate opener, transmitters 2 pcs, Chow App, Chow Bell). Secure Pro Kit (gate opener, transmitters 2 pcs, Chow App, Chow Bell, Chow Cam).





Automation for Garage doors

AMOS & MARBLE 80/100/120



Built-in Security Camera (AMOS Only)

Monitor the door and the garage from one device
Easy to check if the garage door is firmly closed

Extra Safety

Smooth operation with soft start/stop
Obstruction detection sensor
Lighten up every corner of your garage.

Smartphone Control

Remotely open and close doors with the Chow! app
Programming the motor through Chow! app
Extra home security and convenience with the Chow! Cam



Application Diagram

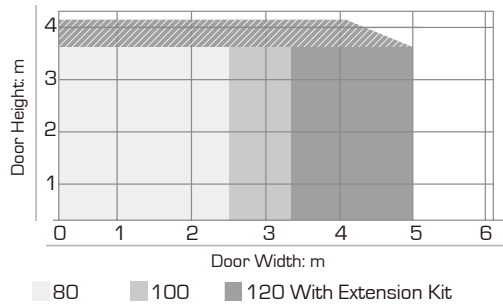

Dimensions

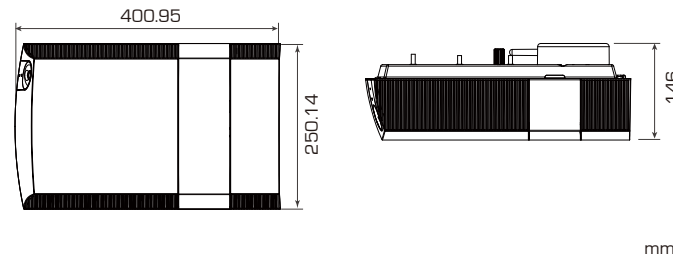

Basic Installation

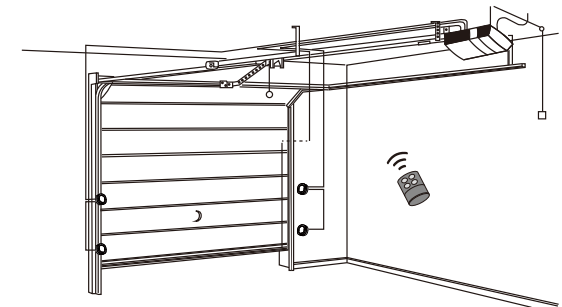

Model Name	AMOS 80/100/120	MARBLE 80/100/120
Peak Pulling Force	800N/1000N/1200N	800N/1000N/1200N
Motor Volt	DC24V	DC24V
Power	80W/100W/144W	80W/100W/144W
Rated Door Area	16m ² /18m ² /24m ²	16m ² /18m ² /24m ²
Rail	Steel	Steel
Rail Length	3.3m/3.6m/3.9m	3.3m/3.6m/3.9m
Drive	Chain/Belt	Chain/Belt
Speed (mm/sec)	140	140
Soft Start / Soft Stop	V	V
Lighting System	LED	LED
Self Learn Force System	V	V

Accessories

Smart Phone Control	V (Standard)	V (Standard)
4 Button Transmitters	X2	X2
Wall Transmitters (Optional)	●	●
Safety Beams (Optional)	●	●
Wireless Keypad (Optional)	●	●
Wireless Doorbell (Optional)	●	●
IP Camera (Optional)	●	●
Built-in IP Security Camera (AMOS Only)	●	

Security System

Basic Access Kit



Gate Opener,
2x Transmitters, Chow! app

Smart Starter Kit

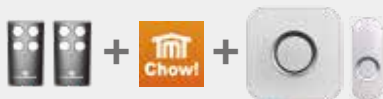

Gate Opener, 2x Transmitters, Chow! app, Chow Bell

Secure Pro Kit

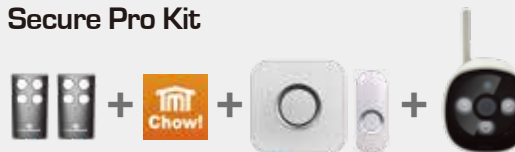

Gate Opener, 2x Transmitters, Chow! app, Chow Bell, Chow Cam

Basic Access Kit (gate opener, transmitters 2 pcs, Chow App). Smart Starter Kit (gate opener, transmitters 2 pcs, Chow App, Chow Bell).
Secure Pro Kit (gate opener, transmitters 2 pcs, Chow App, Chow Bell, Chow Cam).





Automation for Sliding Gates

BOXER 500/800 DC



Key Release



Easy Installation



Smartphone Control



Secure Operation



Battery Backup

Current Detection With LED Display

Allows users to monitor the operation status through a digital display board during installation

Guaranteed Quality

Aluminum die-cast motor base passed 40,000 life-cycle tests with 500/800kg fully loaded gate. UV stabilized over on main motor chassis providing great resistance to outdoor environments

Smartphone Control

Remotely open and close doors with the Chow! app
Programming the motor through Chow! app
Extra home security and convenience with the Chow! Cam from anywhere and any device



Application Diagram

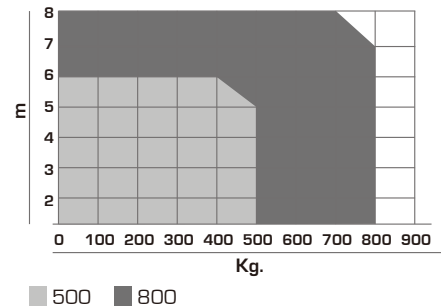

Dimensions

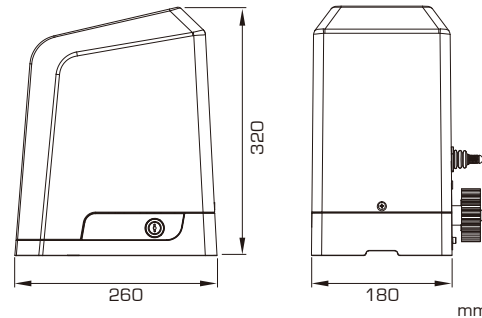

Basic Installation

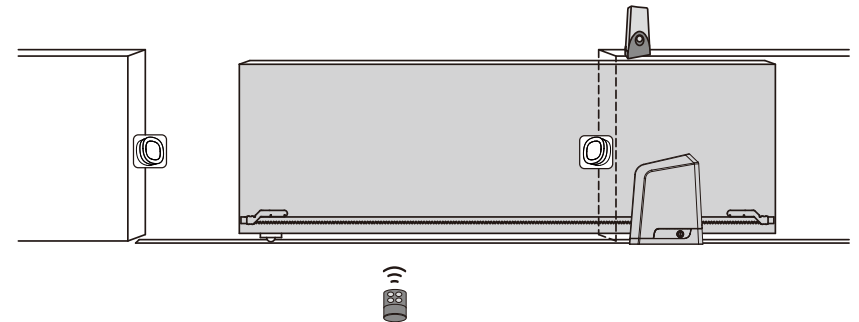

Model Name	BOXER 500	BOXER 800
Technical Feature	DC Sliding Gate Opener	DC Sliding Gate Opener
Max Gate Length	6M	8M
Max Gate Weight	500Kg	800Kg
Power Supply	110-240VAC (50-60Hz)	110-240VAC (50-60Hz)
Motor Power Supply	24VDC	24VDC
Motor Spec No.	5844 Motor L	7152 Motor
RPM	3800RPM	2600RPM/3600RPM
Gear Type	Worm Gear	Worm Gear
Peak Thrust	5000N	8000N
Gate Speed	21.9 cm/sec	25.8 cm/sec
Opening Time	< 27 sec (6M)	< 36 sec (8M)
Duty Cycle	20%	20%
Protection Grade (IP)/ Protection Class	IP 44	IP 44
Working Temperature/ Operating Temperature	-20~50°C	-20~50°C
Absorbed Current (A)	5.5A for Maximum 10 secs	5.5A for Maximum 10 secs
Absorbed Power (W)	144W	144W
Manual Release	Key	Key
Enclosure Dimensions	250mm*170mm*265mm	250mm*170mm*265mm

Security System

Basic Access Kit



Gate Opener,
2x Transmitters, Chow! app

Smart Starter Kit

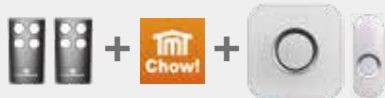

Gate Opener, 2x Transmitters, Chow! app, Chow Bell

Secure Pro Kit



Gate Opener, 2x Transmitters, Chow! app, Chow Bell, Chow Cam

Basic Access Kit (gate opener, transmitters 2 pcs, Chow App). Smart Starter Kit (gate opener, transmitters 2 pcs, Chow App, Chow Bell).
Secure Pro Kit (gate opener, transmitters 2 pcs, Chow App, Chow Bell, Chow Cam).





Automation for Sliding Gates

HUSKY 700/1000/1200

Easy Setup

User-friendly control board with torques for overcurrent and force adjustment

Guaranteed Quality

Solid structure with worm gear to enhance durability

Safe Operation

Open/close gates with precision through limit switch

Soft Star and Soft Close provide smooth operation and crash prevention

Smartphone Control

Remotely open and close doors with the Chow! app

Programming the motor through Chow! app

Extra home security and convenience with the Chow! Cam from anywhere and any device

Application Diagram

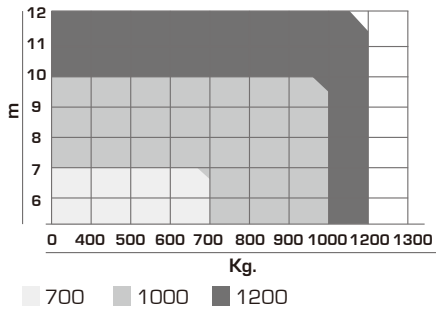

Dimensions

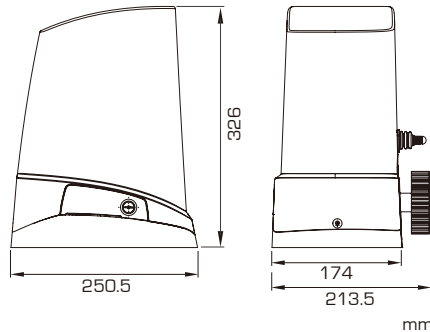

Basic Installation

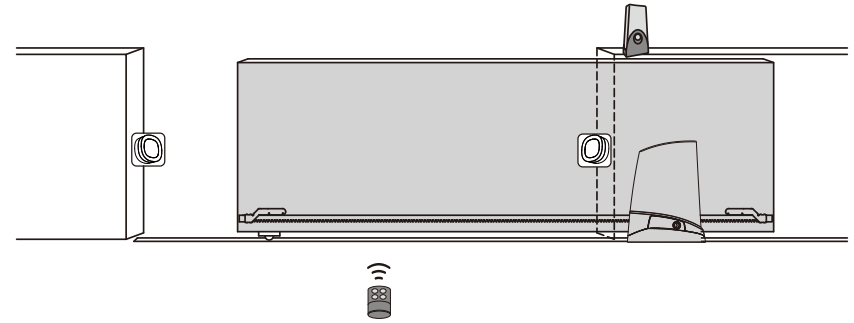

Model Name	HUSKY 700	HUSKY 1000	HUSKY 1200
Technical Feature	AC Sliding Gate Opener	AC Sliding Gate Opener	AC Sliding Gate Opener
Power Supply	AC230V 50Hz	AC230V 50Hz	AC230V 50Hz
Max Gate Length	7M	10M	12M
Max Gate Weight	700Kg	1000Kg	1200Kg
Gear Type	Worm Gear	Worm Gear	Worm Gear
Peak Thrust	7000N	10000N	12000N
Gate Speed	19.78cm/s	19.78cm/s	19.78cm/s
Opening Time	< 17.7 sec	< 17.7 sec	< 27.3 sec
Duty Cycle	20%	20%	20%
Protection Grade (IP)/ Protection Class	IP 44	IP 44	IP 44
Working Temperature/ Operating Temperature	-20~50°C	-20~50°C	-20~50°C
Absorbed Current (A)	1.32A	1.85A	1.94A
Absorbed Power (W)	305W	420W	440W
Manual Release	Key	Key	Key
Enclosure Dimensions	250mm * 174mm * 323mm	250mm * 174mm * 323mm	250mm * 174mm * 323mm



Security System

Basic Access Kit



Gate Opener,
2x Transmitters, Chow! app

Smart Starter Kit

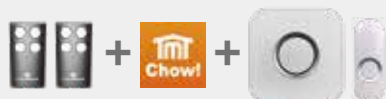

Gate Opener, 2x Transmitters, Chow! app, Chow Bell

Secure Pro Kit

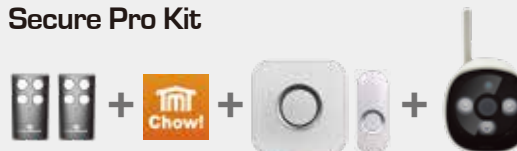

Gate Opener, 2x Transmitters, Chow! app, Chow Bell, Chow Cam

Basic Access Kit (gate opener, transmitters 2 pcs, Chow App). Smart Starter Kit (gate opener, transmitters 2 pcs, Chow App, Chow Bell).
Secure Pro Kit (gate opener, transmitters 2 pcs, Chow App, Chow Bell, Chow Cam).



Economical Choice For Light/Medium Weight Gates

Corrosion resistant treatment for metal surfaces allow motors to handle extreme weather
 Strong structure with durable materials supports intensive use

Easy Manual Release

Gates are able to be released effortlessly with a personal key in the case of power failure.

Smartphone Control

Remotely open and close doors with the Chow! app
 Programming the motor through Chow! app
 Extra home security and convenience with the Chow! Cam from anywhere and any device



Application Diagram

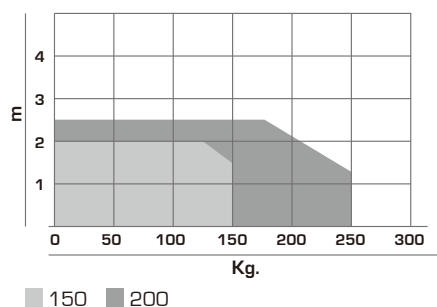

Dimensions

TERRIER150

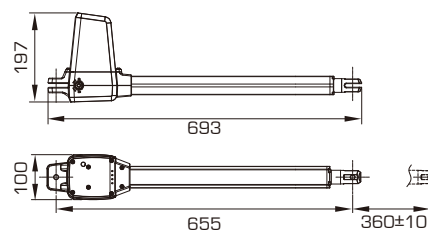

TERRIER200

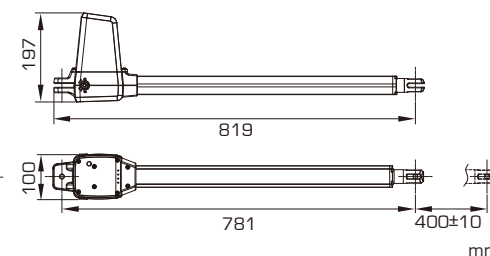

Basic Installation

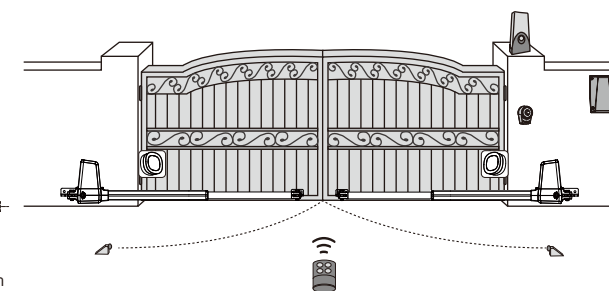

Model Name	TERRIER 150	TERRIER 200
Technical Feature	Swing Gate Opener	Swing Gate Opener
Max Gate Length	2M	2.5M
Max Gate Weight	150Kg	200Kg
Power Supply	110-240VAC (50-60Hz)	110-240VAC (50-60Hz)
Motor Power Supply	24VDC	24VDC
Motor Spec No.	4734	4734
RPM	3800RPM	3800RPM
Gear Type	Worm Gear	Worm Gear
Peak Thrust	2000N	2500N
Operation Stroke	360mm	400mm
Piston Extension	28.9mm/sec	28.9mm/sec
Opening Time	<13 sec	<14 sec
Duty Cycle	20%	20%
Protection Grade (IP)/	IP44	IP44
Protection Class		
Working Temperature/	-20~50°C	-20~50°C
Operating Temperature		
Absorbed Current [A]	4.2A	4.2A
Absorbed Power [W]	100W	100W
Manual Release	Key	Key
Enclosure Dimensions	698mm * 100mm * 197mm	819mm * 100mm * 197mm



Security System

Basic Access Kit



Gate Opener,
2x Transmitters, Chow! app

Smart Starter Kit

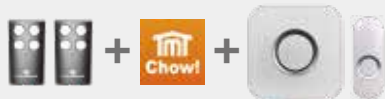

Gate Opener, 2x Transmitters, Chow! app, Chow Bell

Secure Pro Kit



Gate Opener, 2x Transmitters, Chow! app, Chow Bell, Chow Cam

Basic Access Kit (gate opener, transmitters 2 pcs, Chow App). Smart Starter Kit (gate opener, transmitters 2 pcs, Chow App, Chow Bell). Secure Pro Kit (gate opener, transmitters 2 pcs, Chow App, Chow Bell, Chow Cam).



Automation for Swing Gates

MASTIFF 300/400/400L



Key Release



Smartphone Control



Secure Operation



Battery Backup

Current Detection With LED Display

Allows users to monitor the operation status through a digital display board during installation

Premium Model For Medium To Heavy Gate

Design to operate up to 300kg, 350kg and 450kg per leaf on Mastiff swing gate series

Smartphone Control

Remotely open and close doors with the Chow! app

Programming the motor through Chow! app

Extra home security and convenience with the Chow! Cam from anywhere and any device



Application Diagram

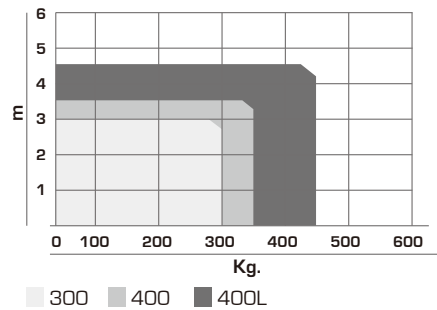

Dimensions

MASTIFF 300

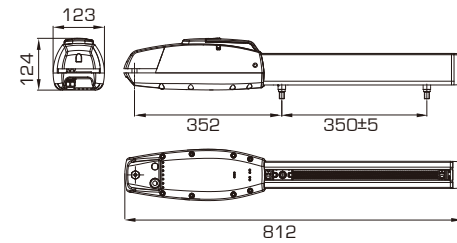

MASTIFF 400

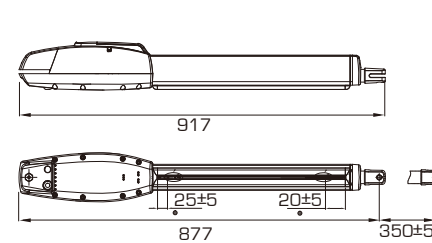

MASTIFF 400L

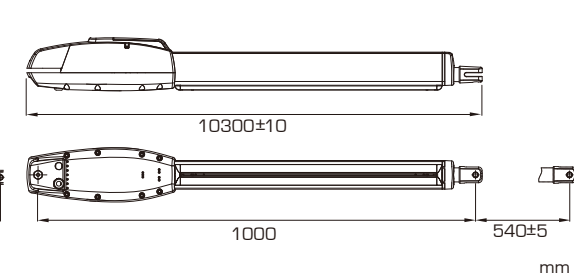

Model Name	MASTIFF 300	MASTIFF 400	MASTIFF 400L
Technical Feature	Swing Gate Opener	Swing Gate Opener	Swing Gate Opener
Max Gate Length	3M	3.5M	4.5M
Max Gate Weight	300Kg	350Kg	450Kg
Power Supply	110-240VAC (50-60Hz)	110-240VAC (50-60Hz)	110-240VAC (50-60Hz)
Motor Power Supply	24VDC	24VDC	24VDC
Motor Spec No.	5540	5540	5540
RPM	2600RPM	2600RPM	2600RPM
Gear Type	Worm Gear	Worm Gear	Worm Gear
Peak Thrust	3000N	3500N	4500N
Operation Stroke	350mm	350mm	540mm
Piston Extension	19.8mm/sec	19.8mm/sec	19.8mm/sec
Opening Time	<18 sec	<18 sec	<27.5 sec
Duty Cycle	20%	20%	20%
Protection Grade (IP)/ Protection Class	IP44	IP44	IP44
Working Temperature/ Operating Temperature	-20~50°C	-20~50°C	-20~50°C
Absorbed Current (A)	5.5A	5.5A	5.5A
Absorbed Power (W)	144W	144W	144W
Manual Release	Key	Key	Key
Enclosure Dimensions	844mm * 115mm * 106mm	917mm*123mm*124mm	1027mm * 123mm * 124mm
Accessories			
Built-in Physical Stopper	●		
Built-in Limit Switch	●	●	●

Security System

Basic Access Kit



Gate Opener,
2x Transmitters, Chow! app

Smart Starter Kit

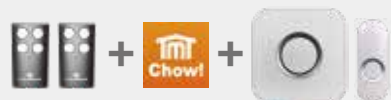

Gate Opener, 2x Transmitters, Chow! app, Chow Bell

Secure Pro Kit

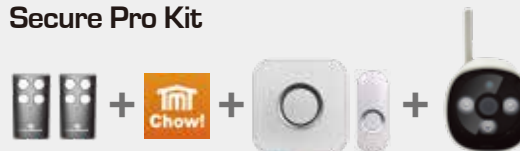

Gate Opener, 2x Transmitters, Chow! app, Chow Bell, Chow Cam

Basic Access Kit (gate opener, transmitters 2 pcs, Chow App). Smart Starter Kit (gate opener, transmitters 2 pcs, Chow App, Chow Bell).
Secure Pro Kit (gate opener, transmitters 2 pcs, Chow App, Chow Bell, Chow Cam).





Automation for Swing Gates PAPILLON 250



Key Release



Easy Installation



Smartphone Control



Secure Operation



Battery Backup

Hassle-Free Installation

Travel limits for gates can be easily set up once system learning is complete

Guaranteed Quality

24VDC electromechanical gear motor with articulated arm
Strong adjustable die-cast aluminum physical stopper

Smartphone Control

Remotely open and close doors with the Chow! app
Programming the motor through Chow! app
Extra home security and convenience with the Chow! Cam from anywhere and any device



Application Diagram

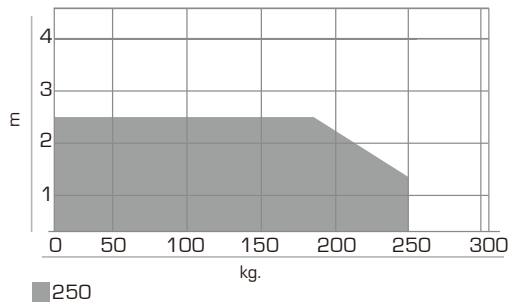

Dimensions

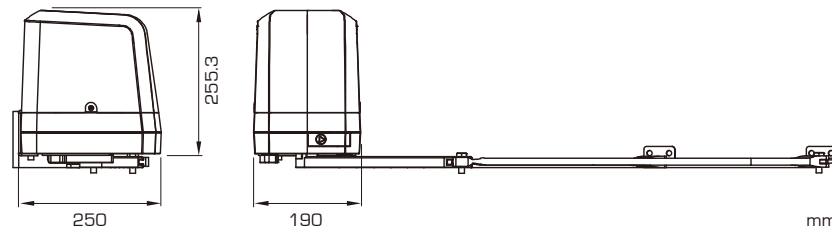

Basic Installation

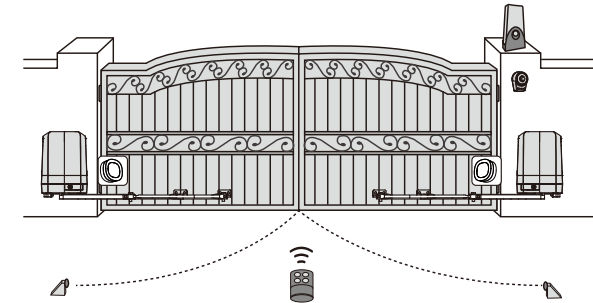

Model Name	PAPILLON 250
Technical Feature	Articulated Arm Opener
Max Gate Length	2.5M
Max Gate Weight	250Kg
Power Supply	110-240VAC (50-60Hz)
Motor Power Supply	24VDC
Motor Spec No.	5540
RPM	2600RPM
Gear Type	Worm Gear
Peak Thrust	2500N
Duty Cycle	20%
Protection Grade (IP)/	IP44
Protection Class	
Working Temperature/	-20~50°C
Operating Temperature	
Absorbed Current (A)	5.5A
Absorbed Power (W)	144W
Manual Release	Key
Enclosure Dimensions	256mm * 187mm * 267mm

Accessories

Built-in Physical Stopper	●
Built-in Limit Switch	●

Security System

Basic Access Kit



Gate Opener,
2x Transmitters, Chow! app

Smart Starter Kit

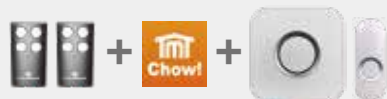

Gate Opener, 2x Transmitters, Chow! app, Chow Bell

Secure Pro Kit

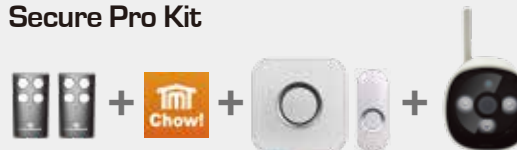

Gate Opener, 2x Transmitters, Chow! app, Chow Bell, Chow Cam

Basic Access Kit (gate opener, transmitters 2 pcs, Chow App). Smart Starter Kit (gate opener, transmitters 2 pcs, Chow App, Chow Bell). Secure Pro Kit (gate opener, transmitters 2 pcs, Chow App, Chow Bell, Chow Cam).





CB Series Control System

Smart Control with Intelligent Functions

- Power input 110VAC/230VAC are both available
- Two backup batteries for power failure
- Built-in radio receiver to match transmitters
- Over-current design which comply with European safety regulation
- Elegant design with easy installation



P1 Wireless Keypad

- 433.92MHz frequency
- Requires 2 AAA batteries
- 50m transmission distance
- 2 transmission channels to control multi automated accesses
- Unique PIN codes for temporary use



FL2 Flashing Light

Flashing Light Powered with 24VDC

- Unique wall lightbox design which maximises light efficiency
- Halogen bulb provides excellent illumination
- Vertical and horizontal installations are both available



H2 Photocell

Photocell of Receiver/Transmitter

- Safety device for up to 15m sensing range
- Power input of AC/DC 12 ~ 24V
- Waterproof design for outdoor environments



TM3 Transmitter

4-Channel Remote

- Four-channel transmitter with programmable features
- Up to 50m transmitting distance
- With rolling code of 433MHz



Nylon Gear Rack

[For Sliding Motor]

- Dimension 1000 x 26.7 x 19.7mm



Photocells / Reflector Type

- Sensing range up to 12m
- Input voltage DC 10-30 V
- Waterproof IP 65
- Dimension 58 x 58 x 20mm



Chow Bell

Smart Wireless Doorbell

- RC2032 battery in push button
- 1.5A AAA batteries 3pcs in receiver (Not Included)
- IP 44 waterproof
- 52 kinds of ringtones
- 4-level adjustable volume
- 450 feet operation range in an open area
- Easy installation and operation



Chow Cam

Outdoor IP Cam

- IP 66 waterproof
- 1280 x 720 pixels
- 0°C ~ 55°C operating temperature
- Supports up to 128GB SD card (Not Included)



Electric Latch

(For Swing Motor)

- Input voltage DC 24V
- Dimension 74 x 61 x 120mm



Metal Stopper

(For Swing Motor)

- Dimension 130 x 130 x 35mm



Wireless Keypad (Indoor)

- Transmitting distance up to 50m
- 4 Channel for programming
- Battery A23 12V 1pce
- Dimension 70 x 120 x 14mm

Never Have to Worry about Power Failure



Backup Battery Set (For Sliding Motor)

[12V/1.3A *2pcs]

- Dimension 98 x 44 x 58mm



Backup Battery Set (For Swing Motor)

[12V/2.2A *2pcs]

- Dimension 70 x 47 x 103mm

